



Information

Brand Name	TONA
Product Name	Bathtub
Material	CAST STONE
Color	White Glossy
Production Process	Seamless butt joint
Installation Method	Freestanding
Faucet	Without faucet
Component	Bathtub+Pop up+Overflow hole+Drain Pipe

Model	YY016-1500W
Specification	1500*740*670mm
N.kg	54.0kg
G.kg	59.8kg
Volume	0.87m ³
Drain _(The distance from to the ground)	140mm
Capacity	185L

Technical drawing

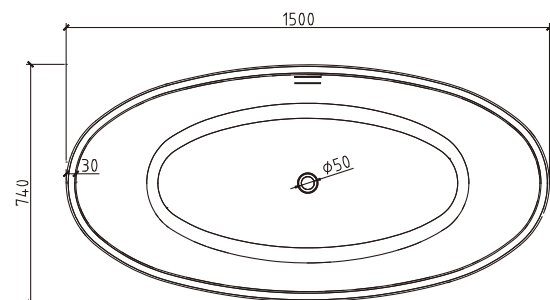
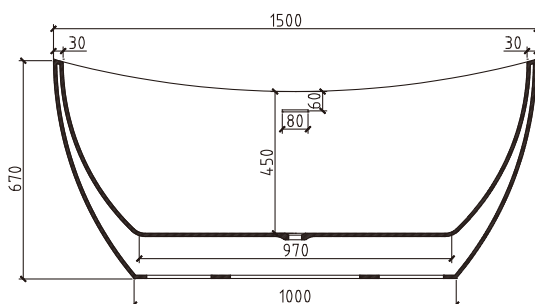

Note: The size is measured manually, with the ±2 cm of error. Please in kind prevail.



Information

Brand Name	TONA
Product Name	Bathtub
Material	CAST STONE
Color	White Glossy
Production Process	Seamless butt joint
Installation Method	Freestanding
Faucet	Without faucet
Component	Bathtub+Pop up+Overflow hole+Drain Pipe

Model	YY016-1700W
Specification	1700*795*680mm
N.kg	62.0kg
G.kg	68.7kg
Volume	1.06m ³
Drain _(The distance from to the ground)	140mm
Capacity	230L

Technical drawing

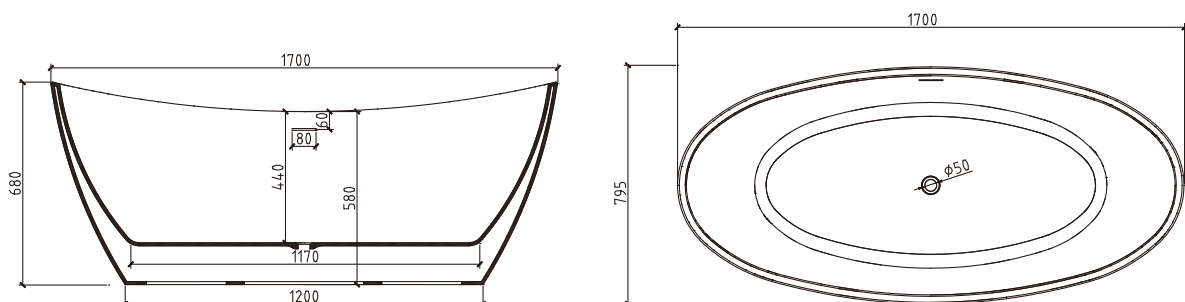

Note: The size is measured manually, with the ± 2 cm of error. Please in kind prevail.