



Information

Brand Name	TONA
Product Name	Bathtub
Material	CAST STONE
Color	White Glossy
Production Process	Seamless butt joint
Installation Method	Freestanding
Faucet	Without faucet
Component	Bathtub+Pop up+Overflow hole+Drain Pipe

Model	YY006-1500W
Specification	1500*750*590mm
N.kg	42.6kg
G.kg	48.4kg
Volume	0.78m ³
Drain _(The distance from to the ground)	120mm
Capacity	210L

Technical drawing

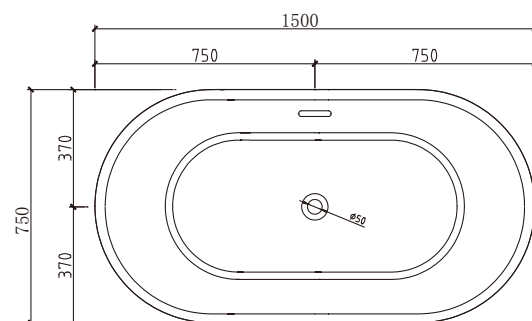
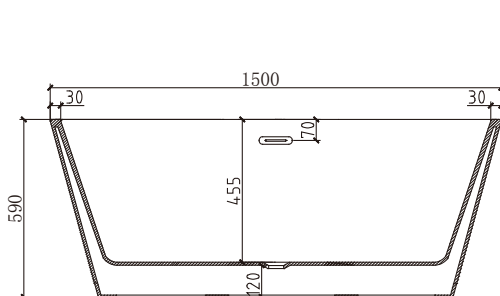

Note: The size is measured manually, with the ± 2 cm of error. Please in kind prevail.

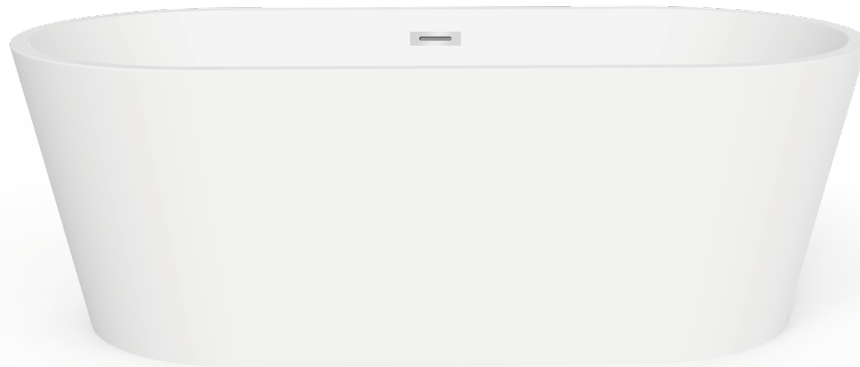

Information

Brand Name	TONA
Product Name	Bathtub
Material	CAST STONE
Color	White Glossy
Production Process	Seamless butt joint
Installation Method	Freestanding
Faucet	Without faucet
Component	Bathtub+Pop up+Overflow hole+Drain Pipe

Model	YY006-1700W
Specification	1700*800*610mm
N.kg	48.3kg
G.kg	54.6kg
Volume	0.97m ³
Drain _(The distance from to the ground)	120mm
Capacity	260L

Technical drawing

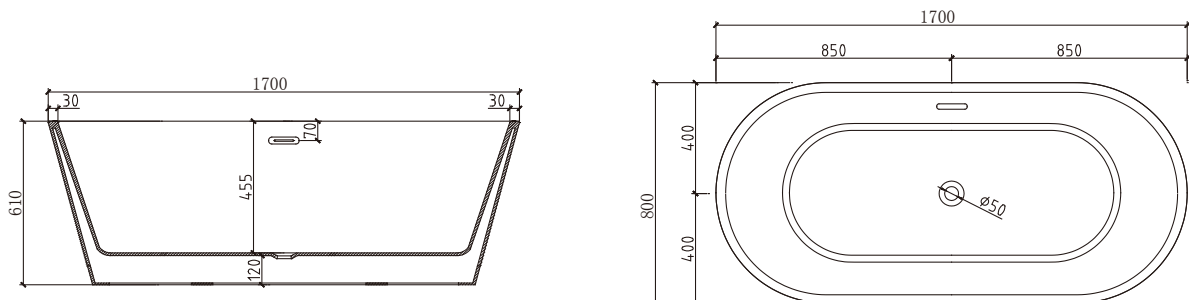

Note: The size is measured manually, with the ± 2 cm of error. Please in kind prevail.